

Två- och fyrpoliga distributionsblock

Stora anslutningar för
inkommande matning

Solida mässingskenor

Förstärkta plastdetaljer

Enkel fastsättning på
DIN-skena

Isolerade skärmar
mellan varje rad

Isolerad nollskena med många
anslutningsmöjligheter

Testad och certifierad i
enlighet med IEC 60947-7-1

Skyddslock = beröringsskyddade
anslutningar

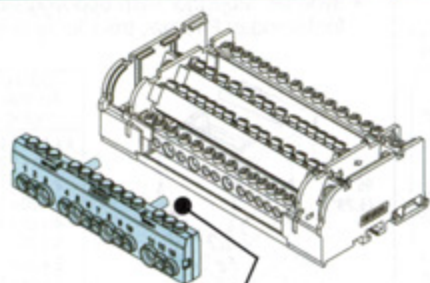

Mekanisk fixering &
elektrisk anslutning

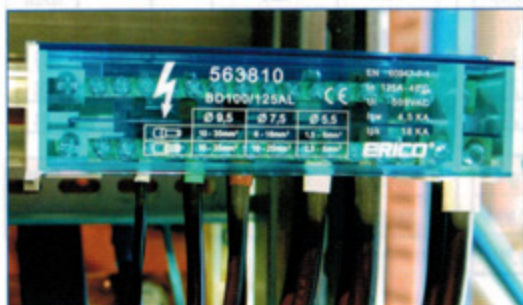
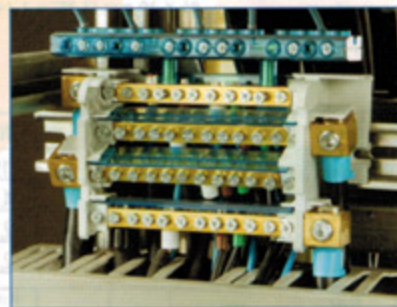
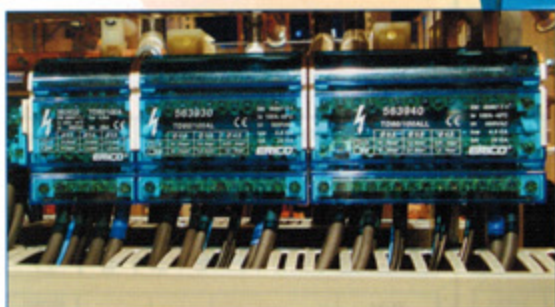

Två- och fyrpoliga distributionsblock

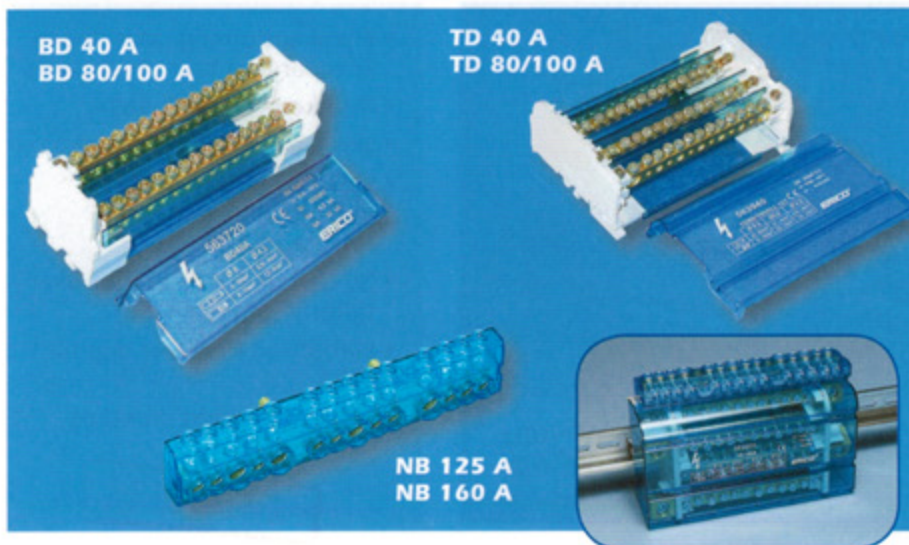

- Maximalt med anslutningar på minimal yta
- Enkelt att ansluta
- Transparent beröringsskydd
- Självslöcknande: UL 94 V-0
- Säkra anslutningar
- Montering på DIN skena eller montageplåt*
- Anslutning med eller utan ändhylsa
- Halogenfri
- RoHS Kompatibel

IEC 60947-7-1

2 & 4 POL 40 A 2 pol BD 40 A

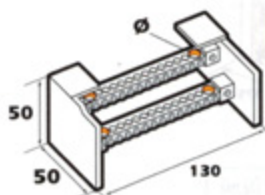

- Icw kA rms 1s : 4,5
- IPk kA : 22
- Ui : 500 V AC/DC

BD 40 A - 16 ANSLUTNINGAR

Wiring	Ø	I(N.m)
6-16 4-10 x2	6	2-3
1,5-4 0,75-4 x15	4,3	1,2-1,5

4 pol TD 40 A

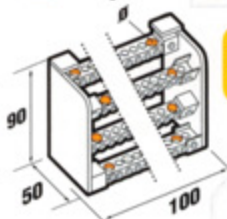

- Icw kA rms 1s : 4,5
- IPk kA : 22
- Ui : 500 V AC

TD 40 A - 12 ANSLUTNINGAR

Wiring	Ø	I(N.m)
6-16 4-10 x2	6	2-3
1,5-4 0,75-4 x11	4,3	1,2-1,5

- * c-c mått för borrning:
 • BD 40 A = 110 mm
 • TD 40 A = 80 mm

Art.nr.	Beskrivning	kg/lbs
563720	BD 40 A	0,22/0,49
563740	TD 40 A	0,33/0,73

2 & 4 POL 80/100 A 2 pol BD 80/100 A

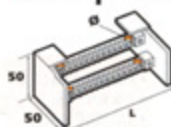

- Icw kA rms 1s : 4,5
- IPk kA : 20
- Ui : 500 V AC/DC

BD 80/100 A - 6 ANSLUTNINGAR

Wiring	Ø	I(N.m)
10...25 10...25 x1	8,5	2-3
1,5...4 0,75...4 x3	4,5	1,2-1,5
2,5...6 1,5...6 x3	5,5	2-3

BD 80/100 AL - 14 ANSLUTNINGAR

Wiring	Ø	I(N.m)
10...25 10...25 x2	8,5	2-3
1,5...4 0,75...4 x6	4,5	1,2-1,5
2,5...6 1,5...6 x7	5,5	2-3

4 pol TD 80/100 A



- Icw kA rms 1s : 4,5
- IPk kA : 20
- Ui : 500 V AC

TD 80/100 A - 6 ANSLUTNINGAR

Wiring	Ø	I(N.m)
10...25 10...25 x1	8,5	2-3
1,5...4 0,75...4 x3	4,5	1,2-1,5
2,5...6 1,5...6 x3	5,5	2-3

TD 80/100 AL - 10 ANSLUTNINGAR

Wiring	Ø	I(N.m)
10...25 10...25 x2	8,5	2-3
1,5...4 0,75...4 x4	4,5	1,2-1,5
2,5...6 1,5...6 x5	5,5	2-3

TD 80/100 ALL - 14 ANSLUTNINGAR

Wiring	Ø	I(N.m)
10...25 10...25 x2	8,5	2-3
1,5...4 0,75...4 x6	4,5	1,2-1,5
2,5...6 1,5...6 x7	5,5	2-3

- * c-c mått för borrning:
 • BD 80/100 A = 45 mm
 • BD 80/100 AL = 110 mm
 • TD 80/100 A = 45 mm
 • TD 80/100 AL = 80 mm
 • TD 80/100 ALL = 110 mm

Art.nr.	Beskrivning	L
563900	BD 80/100 A	64
563910	BD 80/100 AL	130
563920	TD 80/100 A	64
563930	TD 80/100 AL	100
563940	TD 80/100 ALL	130

NOLLSKENA

- Utökade anslutningsmöjligheter
- Elektrisk direktkontakt
- Starkt mekaniskt montage
- Transparent beröringsskydd

NY

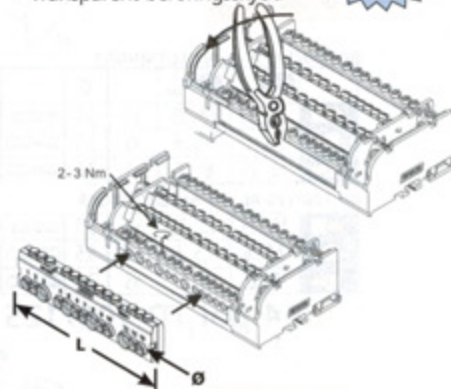

- Nollskena → 563830 – Solida skenor
 563841 → 563840 – Solida skenor
 Nollskena → 563200 – Solida skenor
 563201 → 563990 – Solida skenor

NB 125 A

- Icw kA rms 1s : 4,5
- IPk kA : 30

Wiring	Ø	I(N.m)
10-25 6-16 x3	7,5	2-3
2,5-6 1,5-6 x9	5,5	2-3

NB 160 A

- Icw kA rms 1s : 6,2
- IPk kA : 35

Wiring	Ø	I(N.m)
10-35 10-25 x4	8,5	2-3
2,5-16 1,5-16 x10	7,2	2-3

Art.nr.	Beskrivning	L
563841	NB 125 A	142
563201	NB 160 A	170

Två- och fyrpoliga distributionsblock

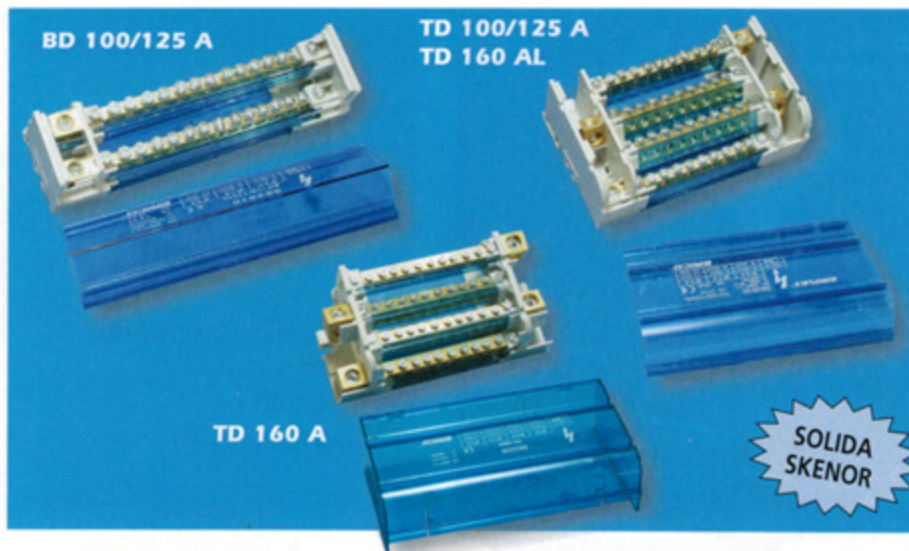

- Enkel anslutning: Matningen är separerad från utgångarna
- Nollskena: 125A & 160A
- Skruv eller DIN-montage*
- Stora anslutningar för inkommande matning: säkra anslutningar
- Ny design: solida skenor ökar tillförlitligheten
- Förbättrad Icc klarar upp till 35kA
- Starkt mekaniskt montage

IEC 60947-7-1

2 & 4 POL 100/125 A

2 pol BD 100/125 A

• Ui : 690 VAC/DC



BD 100/125 A - 6 ANSLUTNINGAR

				Ø		I'(N.m)
	10...35	10...35	x1	9,5		6-7
	2,5...6	1,5...6	x5	5,5		2-3
	10...25	6...16	x1	7,5		2-3

BD 100/125 AL - 14 ANSLUTNINGAR

	10...35	10...35	x1	9,5		6-7
	2,5...6	1,5...6	x11	5,5		2-3
	10...25	6...16	x3	7,5		2-3

4 pol TD 100/125 A

• Ui : 690 VAC



TD 100/125 A - 6 ANSLUTNINGAR

				Ø		I'(N.m)
	10...35	10...35	x1	9,5		6-7
	2,5...6	1,5...6	x5	5,5		2-3
	10...25	6...16	x1	7,5		2-3

TD 100/125 AL - 10 ANSLUTNINGAR

	10...35	10...35	x1	9,5		6-7
	2,5...6	1,5...6	x7	5,5		2-3
	10...25	6...16	x3	7,5		2-3

TD 100/125 ALL - 14 ANSLUTNINGAR

	10...35	10...35	x1	9,5		6-7
	2,5...6	1,5...6	x11	5,5		2-3
	10...25	6...16	x1	7,5		2-3
	10...35	10...25	x2	8,5		2-3

* c-c mått för borrning:

- BD 100/125 A = 74 mm
- TD 100/125 A = 89 mm
- BD 100/125 AL = 142 mm
- TD 100/125 AL = 127 mm
- TD 100/125 ALL = 162 mm

Art.nr.	Beskrivning	Icw	Ipk			L
563800	BD 100/125 A	4,5	30	1	0,16	94
563810	BD 100/125 AL	4,5	25	1	0,27	162
563820	TD 100/125 A	4,5	30	1	0,33	109
563830	TD 100/125 AL	4,5	30	1	0,44	147
563940	TD 100/125 ALL	4,5	21	1	0,55	182

4 POL 160 A

TD 160 A

- Icw KA rms Is : 8,2
- Ipk KA : 35
- Ui : 690 VAC

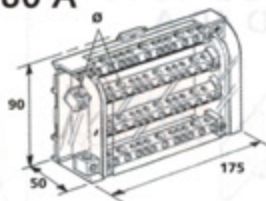

TD 160 A : 11 ANSLUTNINGAR

				Ø		I'(N.m)
	10...50	10...50	x1	12		8-10
	10...35	10...25	x3	8,5		2-3
	2,5...16	1,5...16	x7	7,2		2-3
	2,5...6	1,5...6	x1	5,5		2-3

* C/C mått för borrning: 160 mm

Art.nr.	Beskrivning		
563200	TD 160A	1	0,606

4 POL 160 A

TD 160 AL

- Icw KA rms Is : 8,2
- Ipk KA : 35
- Ui : 690 VAC

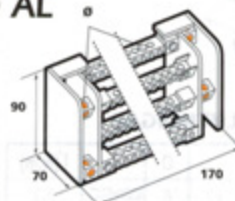

TD 160 AL - 11 ANSLUTNINGAR

				Ø		I'(N.m)
	10...50	10...50	x1	12		8-10
	10...35	10...25	x3	8,5		2-3
	2,5...16	1,5...16	x8	7		2-3

* C/C mått för borrning: 150 mm.

Art.nr.	Beskrivning		
563990	TD 160 AL	1	0,74